



AT&T

LOCATION BRANDING DOCUMENT

City/State: Vienna, VA 22180
 Address: 211 East Maple Avenue
 Creation Date: 12-04-17
 Revised: 03-11-19

This original drawing is provided as part of a planned project and is not to be exhibited, copied or reproduced without the written permission of Federal Heath Sign Company, LLC or its authorized agent.

Revisions:	R4 11.20.18 GB Update S1/Pg.6 to DID Stds.
R1 EBD 12.6.17 Added raceway color to book.	R5 3.11.19 BW Revise LED specs for S1 (as per architectural board).
R2 BW 12.15.17 Update code page & revise door vinyl.	
R3 BW 1.16.18 Add restoration page.	
Colors Depicted In This Rendering May Not Match Actual Finished Materials. Refer To Product Samples For Exact Color Match.	
Client Approval/Date:	
Landlord Approval/Date:	

Account Rep:	Mark Webb
Project Manager:	Susan Seeber
Drawn By:	Edward DeLaney
Underwriters Laboratories Inc.	ELECTRICAL TO USE U.L. LISTED COMPONENTS AND SHALL MEET ALL N.E.C. STANDARDS
ALL ELECTRICAL SIGNS ARE TO COMPLY WITH U.L. 48 AND ARTICLE 600 OF THE N.E.C. STANDARDS, INCLUDING THE PROPER GROUNDING AND BONDING OF ALL SIGNS.	

Project / Location:
AT&T
 Retail
 Store #119894
 211 East Maple Avenue
 Vienna, VA 22180

Job Number:	23-45554-10
Date:	12/04/17
Sheet Number:	1 Of 8
Design Number:	23-45554-10 R5

This original drawing is provided as part of a planned project and is not to be exhibited, copied or reproduced without the written permission of Federal Heath Sign Company, LLC or its authorized agent. © 2008

Branding Summary

Ground Signs	Allowed by Code	Currently Installed	Current % Utilized	Proposed	Proposed % Utilized	% Delta
Height (ft.):	0	0	0%	0	0%	0.0%
Number:	0	0	0%	0	0%	0.0%
Square Footage (ft.):	0	0	0%	0	0%	0.0%

Wall Signs	Allowed by Code	Currently Installed	Current % Utilized	Proposed	Proposed % Utilized	% Delta
Height (ft.):	36	36	100%	24	67%	-33.3%
Number:	1	1	100%	1	100%	0.0%
Square Footage (ft.):	34	39	115%	34	100%	-12.8%

Total Signage	Allowed by Code	Currently Installed	Current % Utilized	Proposed	Proposed % Utilized	% Delta
Number:	1	1	100%	1	100%	0.0%
Square Footage (ft.):	34	39	115%	34	100%	-12.8%

* % Delta is calculated: proposed signage / current signage**

Ground Signs

Existing:	0	Removed:	0
New:	0	Removed:	0
Net Total:	0		

Tenant Panel Only Currently Installed?

YES:

QTY:

Wall Signs

Existing:	1	Removed:	1
New:	1	Removed:	1
Net Total:	1		

Total Primary Signs

Existing:	1	Removed:	1
New:	1	Removed:	1
Net Total:	1		

Branding Rationale / Comments

2 sf/lf of building frontage, including all exterior and interior signs. See Note #1 - Window signs are allowed at 25% of total transparent glass area on each side of the building. Sign area per business shall not exceed 10 sf on any street frontage for window signs.

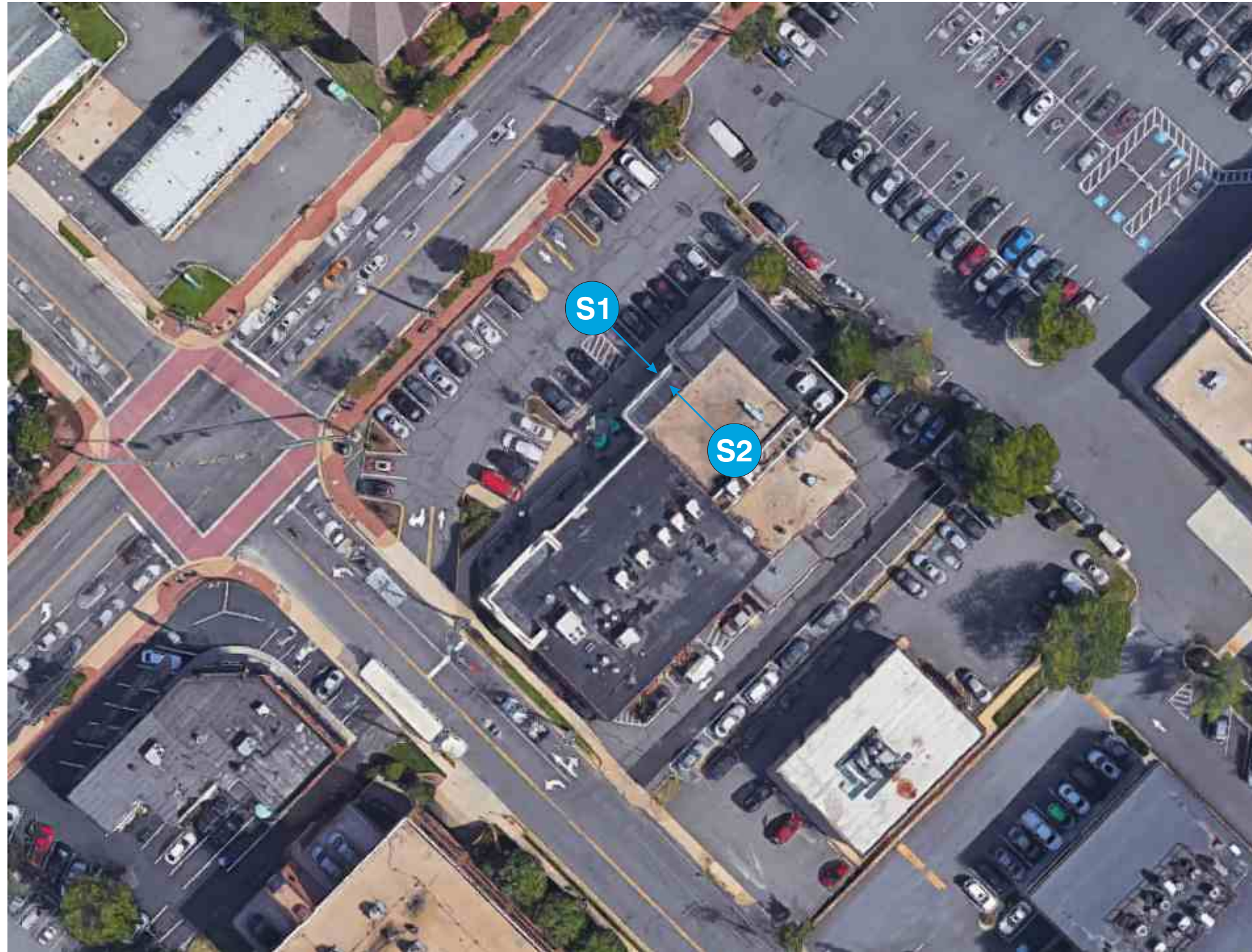

SIGN SCHEDULE	
S1	AR-IL-RWY-24-HORZ-BLACK LETTERS - BLUE GLOBE ONE (1) REQUIRED
S2	DOOR VINYL REPLACE EXISTING ONE (1) SET REQUIRED

SITE PLAN
N.T.S.

S1

AR-IL-Rwy-24-Horz-Black Letters-Blue Globe New Globe & Letterset to Replace Existing Sign

Scope of Work:

Remove existing letterset, patch and repaint fascia (verify exact brick color), if required, to like-new condition. Raceway to be painted SW6385.

Manufacture, ship & install new raceway globe & letterset on fascia, as shown.

NOTE: Standard raceway globe & letterset to replace existing globe & letterset on fascia.

BEFORE



AFTER



SEE DETAILS ON SHEET 5.

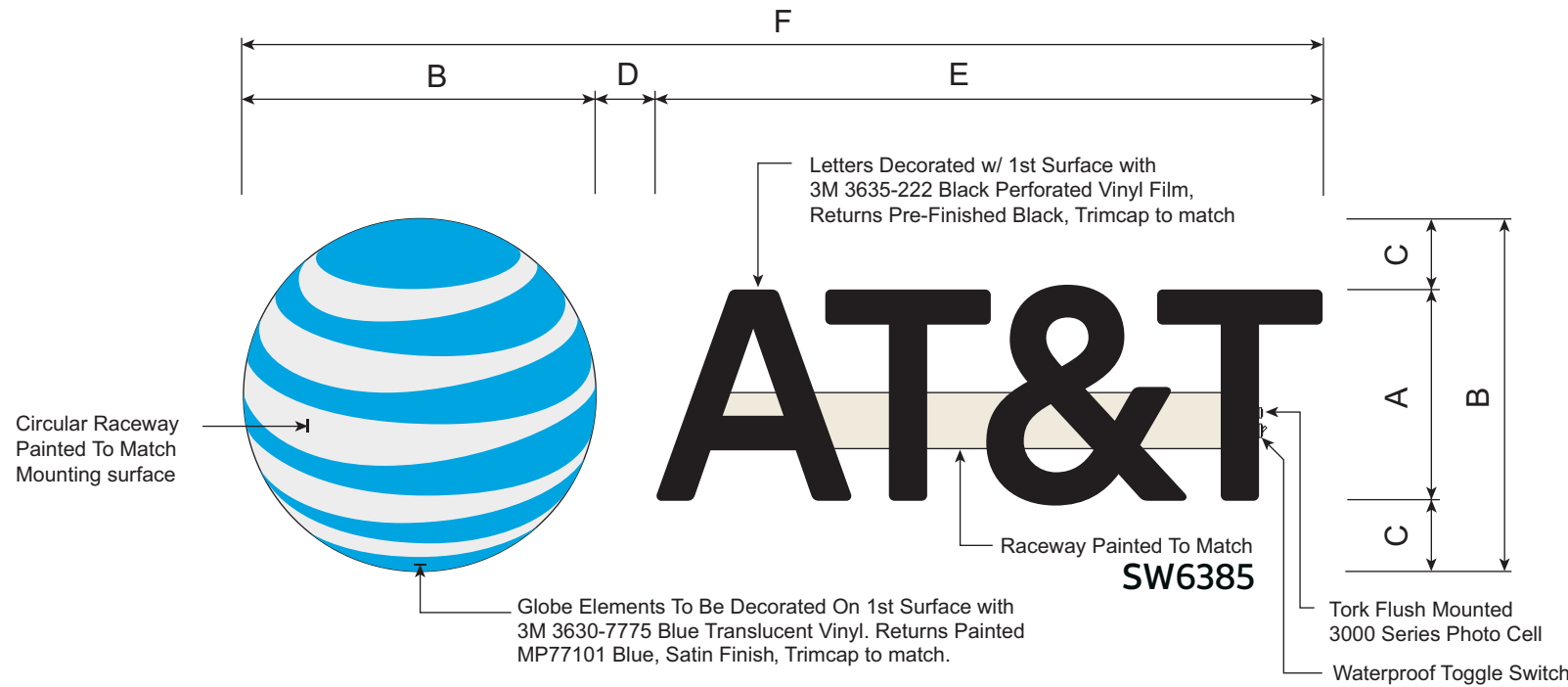

Illum. Raceway Black Letters & Blue Globe - Horizontal Layout

Not To Scale

Sign Model	A	B	C	D	E	F	Element SqFt	Overall SqFt
AR-IL-Rwy-30-Black Ltrs-Blue Globe-Horiz	30"	50"	10"	8.54"	94.38"	152.91"	37.02 Sq.Ft.	53.09 Sq.Ft.
AR-IL-Rwy-24-Black Ltrs-Blue Globe-Horiz	24"	40"	8"	6.84"	75.5"	122.39"	23.7 Sq.Ft.	34 Sq.Ft.
AR-IL-Rwy-18-Black Ltrs-Blue Globe-Horiz	18"	30"	6"	5.125"	56.63"	91.66"	13.33 Sq.Ft.	19.10 Sq.Ft.

General Notes

- LED Modules & Power Supplies As Provided By GE Current (888)694-3533, www.tetradrawings@ge.com
- GE Current Modules to be: GEMS2432 - 3200K
- Manufacture Shall Coordinate With LED Provider To Determine LED Optimum Installation Configuration.
- LED Modules to be installed with VHB tape in conjunction with silicone adhesive or mechanical fastener.
- 1" Jewelite trimcap with #8x1/2" self-tapping phillips screws, color to match return.
- Letterset and globe to have disconnect switch and photocell.
- Mounting spacers are to be painted to match the mounting surface.

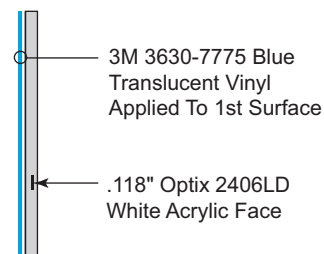

Globe Vinyl Application

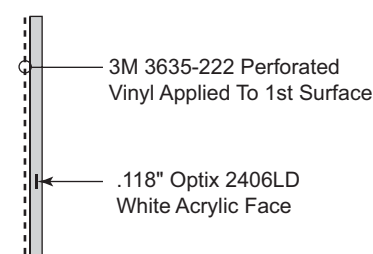

Letters Vinyl Application

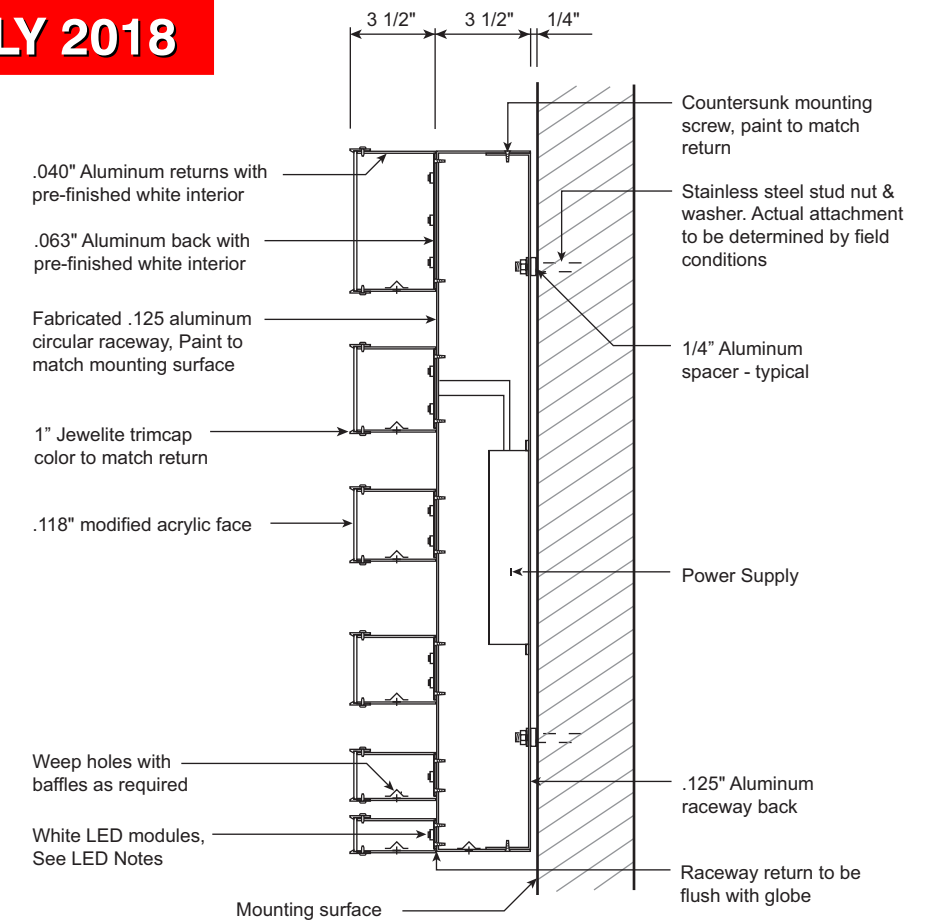

Typical Globe Section

Not To Scale

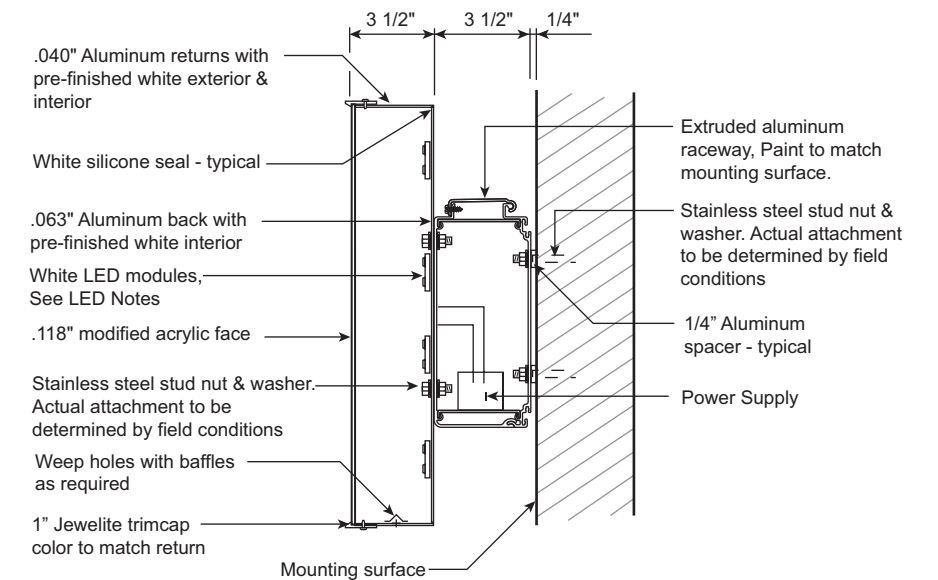

Typical Letter Section

Not To Scale

Scope of Work:

Remove existing door vinyl & clean glass on glass doors.

NOTE: One (1) set of replacement vinyl required.

Manufacture & install new door vinyl logo & hours, as shown.

BEFORE



AFTER



SEE DETAILS ON SHEET 7.

NOTE: One (1) set of replacement vinyl required.

**Store Hours shown are sample only.
Actual store hours are to be verified
prior to manufacturing.**

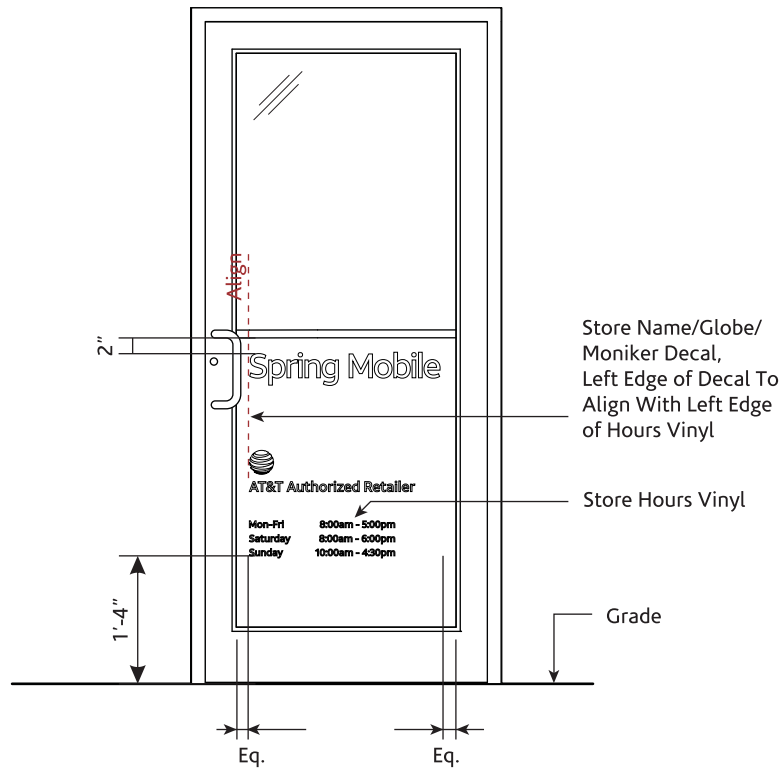

Typical Installation - Single Door

Scale: 1/2" = 1'-0"

General Notes

1. Typeface for "Store Hours" and days of the week to be: ATT Aleck Sans Medium

Typeface for all other copy to be: ATT Aleck Sans Regular

2. Vinyl to be 3M 3630-7725-10 White Vinyl applied to first surface of glass

3. Sample Layouts Shown, Message Will Vary By Site Requirements



AR-V-1 Layout

Scale: 3" = 1'-0"

NOTE: Sample Hours Shown, Actual Store Hours Will Vary By Site.